





















































Lindab **Ventiler**

Monterings-, mätning- injusterings- och skötselanvisningar

Sortimentsöversikt

Produkt				Passar till							
				Ramar med gängor för bajonettfattning			Ramar med spår för fjäderfattning		Täckram med spår för don med fjäderbygelhållare	Slät ram för don med plattfjäderhållare	Kanal/ Detalj
Tilluft	WTK	Tilluftsdon					VRFU 	VRFM 	VRR 		
	VTTB	Tilluftsdon					VRFU 	VRFM 	VRR 		
	SHH	Spridare									Kanal
	KPT	Ventil								ILVRU 	Kanal/ Detalj
	KI	Tilluftsdon		VRGU 	VRGL 	VRGM 					
	KIR	Tilluftsdon		VRGU 	VRGL 	VRGM 					
	TAV	Tallriksventil									

Produkt				Passar till							
				Ramar med gängor för bajonettfatning			Ramar med spår för fjäderfatningr		Täckram med spår för don med fjäderbygelhållare	Slät ram för don med plattfjäderhållare	Kanal/ Detalj
Frånluft	KVB	Kontrollventil					VRFU 	VRFM 	VRR 		
	KDPF	Kontrollventil		VRGU 	VRGL 	VRGM 	VRFU 	VRFM 			
	KVG Ø 100–160	Kontrollventil					VRFU 	VRFM 	VRR 		
	KVG Ø 200	Kontrollventil		VRGU 	VRGL 	VRGM 					
	KU	Kontrollventil		VRGU 	VRGL 	VRGM 					
	KSU	Ventil		VRGU 	VRGL 	VRGM 					
	KPF	Frånluftsdon								ILVRU 	Kanal/ Detalj
Ingen luft	TLO	Täcklock					VRFU 	VRFM 	VRR 		

När man använder de olika k-faktorerna

k-faktor typ: B (Böj 90°)

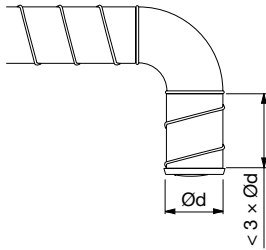

k-faktor typ: D (Kanal)

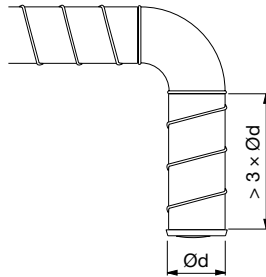

k-faktor typ: T (T-stycke)

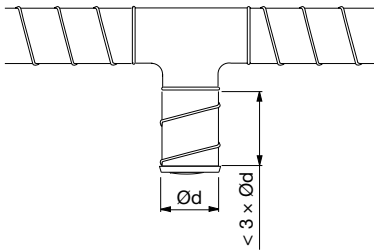

k-faktor typ: D (Kanal)

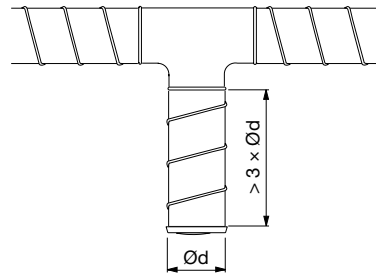

Förklaringar

Mätning av luftflöde

$$q = k \cdot \sqrt{\Delta p_m} \quad \Delta p_m = \left(\frac{q}{k}\right)^2$$

där



q	är	luftflöde	[l/s]
Δp_m	är	mättrycksdifferens	[Pa]
k	är	korrektionsfaktor, se tabeller	[-]

Tabeller

a	är	inställning av ventilskiva eller -kona	[mm]
n	är	inställning av ventilskiva eller -kona	[antal öppningsvarv]
m	är	pluggning av öppning	[antal öppna hål]

D	är	ventil monterad i en kanal
B	är	ventil monterad i en böj 90°
T	är	ventil monterad i ett T-rör

WOSP	är	utan styrplåt
WSP	är	med styrplåt

	är	rekommenderad metod
	är	ej rekommenderad metod

Tilluftsdon

WTK

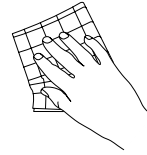
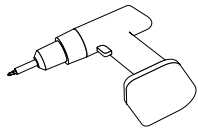

Ø125
Alt 1

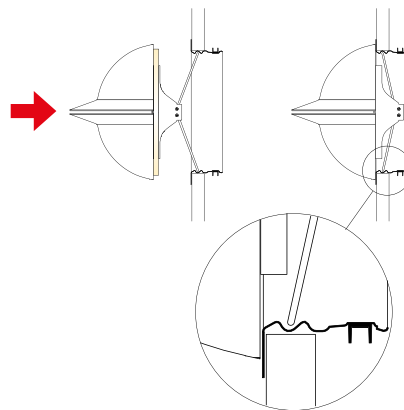
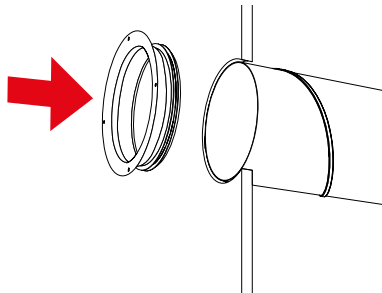
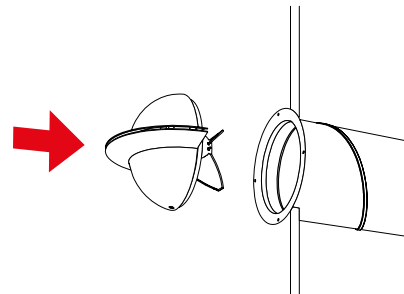
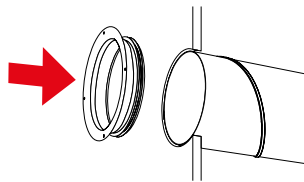

Ø100

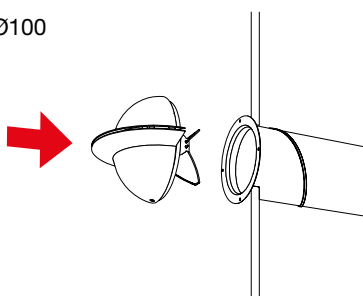

Ø125
Alt 2

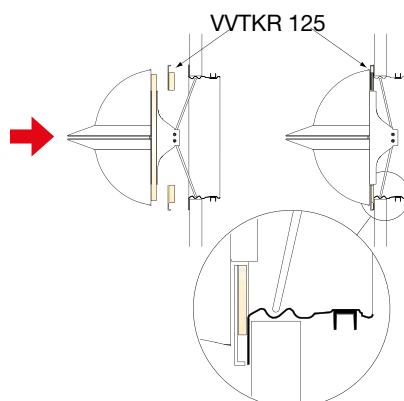
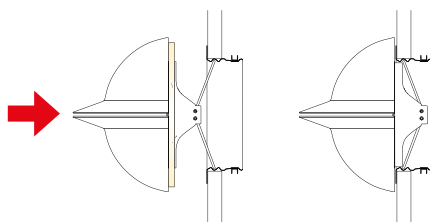
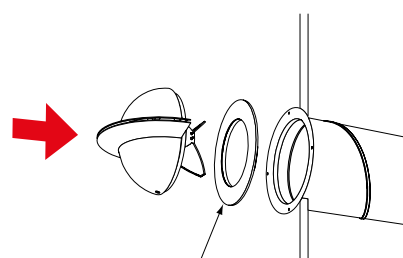

Tilluftsdon

WTK

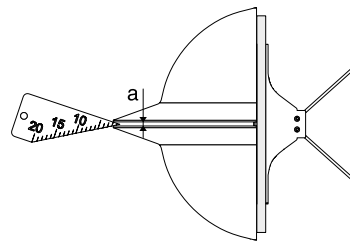
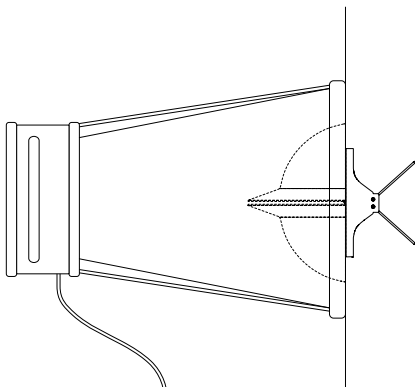
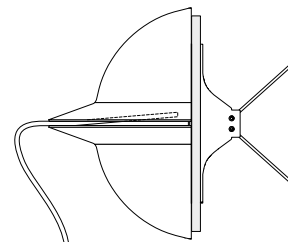
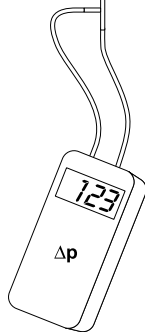
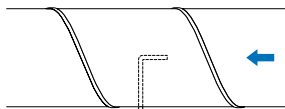
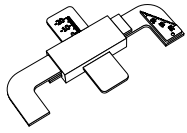

K-faktorer gäller endast produkter som producerats efter Okt 1, 2025.

Ø mm	Monterad i	Inställning a [mm]				
		a	5	7	9	12
100	Duct	k	2,30	3,00	3,80	4,60
		a	5	7	9	12
125	Duct	k	2,30	3,00	3,80	4,60
		a	5	7	9	12

Tilluftsdon

WTK

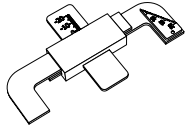

Ø mm	Monterad i	Inställning a [mm]						
		a	6	8	10	12		
100	Kanal	k	1,14	1,44	1,85	2,48		
		a	6	7	8	10	12	16
125	Kanal	k	1,25	1,51	1,87	2,16	2,73	3,61

Tilluftsdon

VTTB

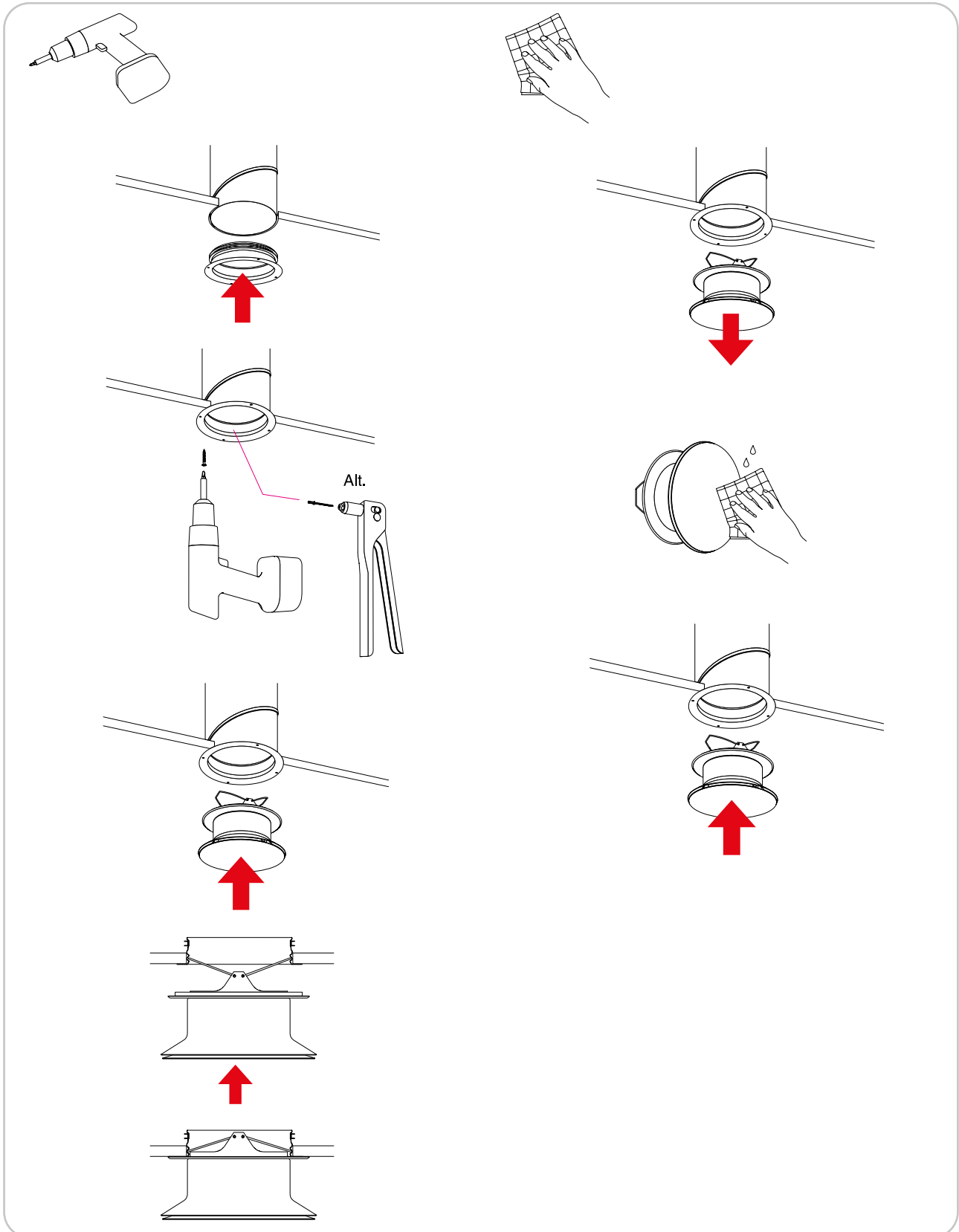

Tilluftsdon

VTTB

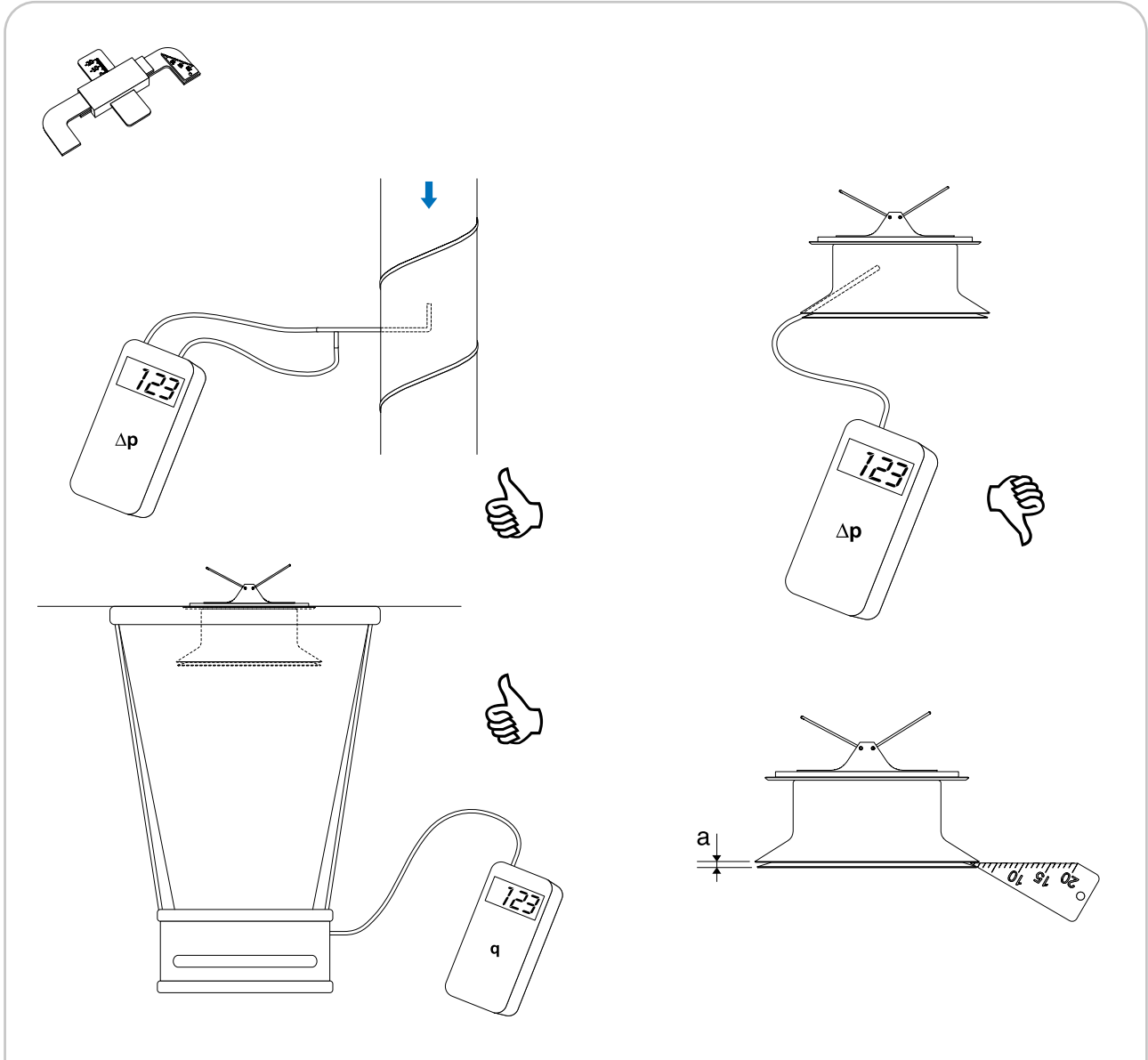

K-faktorer gäller endast produkter som producerats efter Okt 1, 2025.

Ø mm	Monterad i	Inställning a [mm]						
		a	2	4	6	9	12	Fullt öppen
100	Kanal	k	0,80	1,60	2,30	3,30	4,40	5,20
		a	4	5	7	9	12	Fullt öppen
125	Kanal	k	2,00	2,40	3,30	4,00	5,00	5,40
		a	4	6	9	12	Fullt öppen	
160	Kanal	k	2,20	3,20	4,60	5,90	7,20	

Tilluftsdon

VTTB

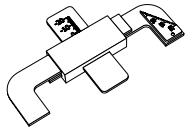

Ø mm	Monterad i	Inställning a [mm]									
		a	4	5	6	7	8	10	12	16	
100	Kanal	k	1,29	1,43	1,82	2,01	2,34	2,98	3,46	4,34	
		a	4	5	6	7	8	10	12	16	
125	Kanal	k	1,54	1,98	2,28	2,71	3,20	3,90	4,52	5,85	
		a	5	6	7	8	10	12	16	20	
160	Kanal	k	2,60	3,23	3,71	3,94	5,03	5,83	7,33	8,40	
		a	5	6	7	8	10	12	16	20	

Spridare SHH

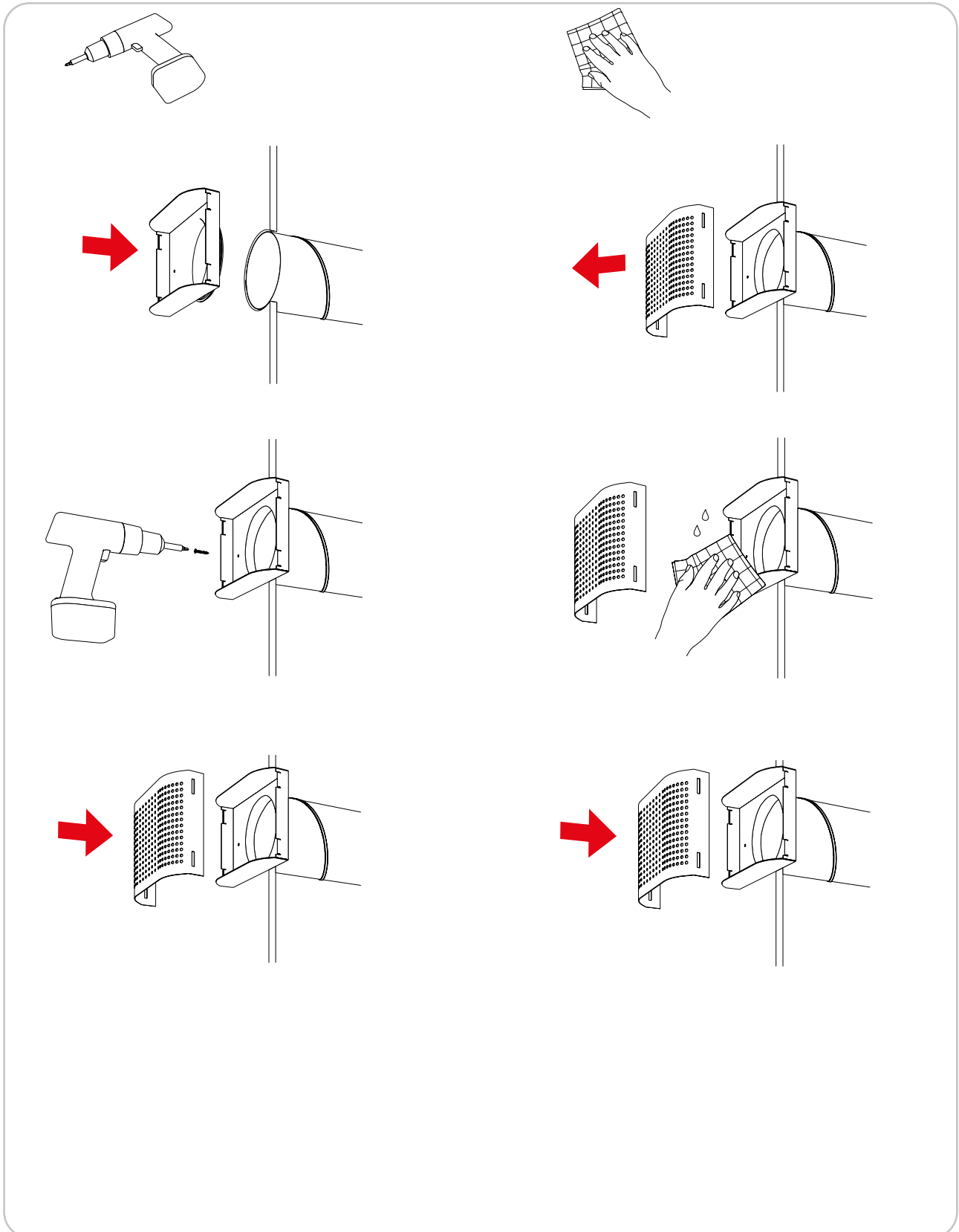

Spridare SHH

Ø mm	Spridare monterad i	Inställning n [antal öppna rader]							
		n	2	4	6	8	10	12	14
100	Kanal	k	0,7	1,2	1,7	2,3	2,7	3,1	3,6
		n	2	4	6	8	10	12	14
125	Kanal	k	0,7	1,2	1,8	2,3	2,8	3,3	3,9
		n	2	4	6	8	10	12	14

Ventil

KPT

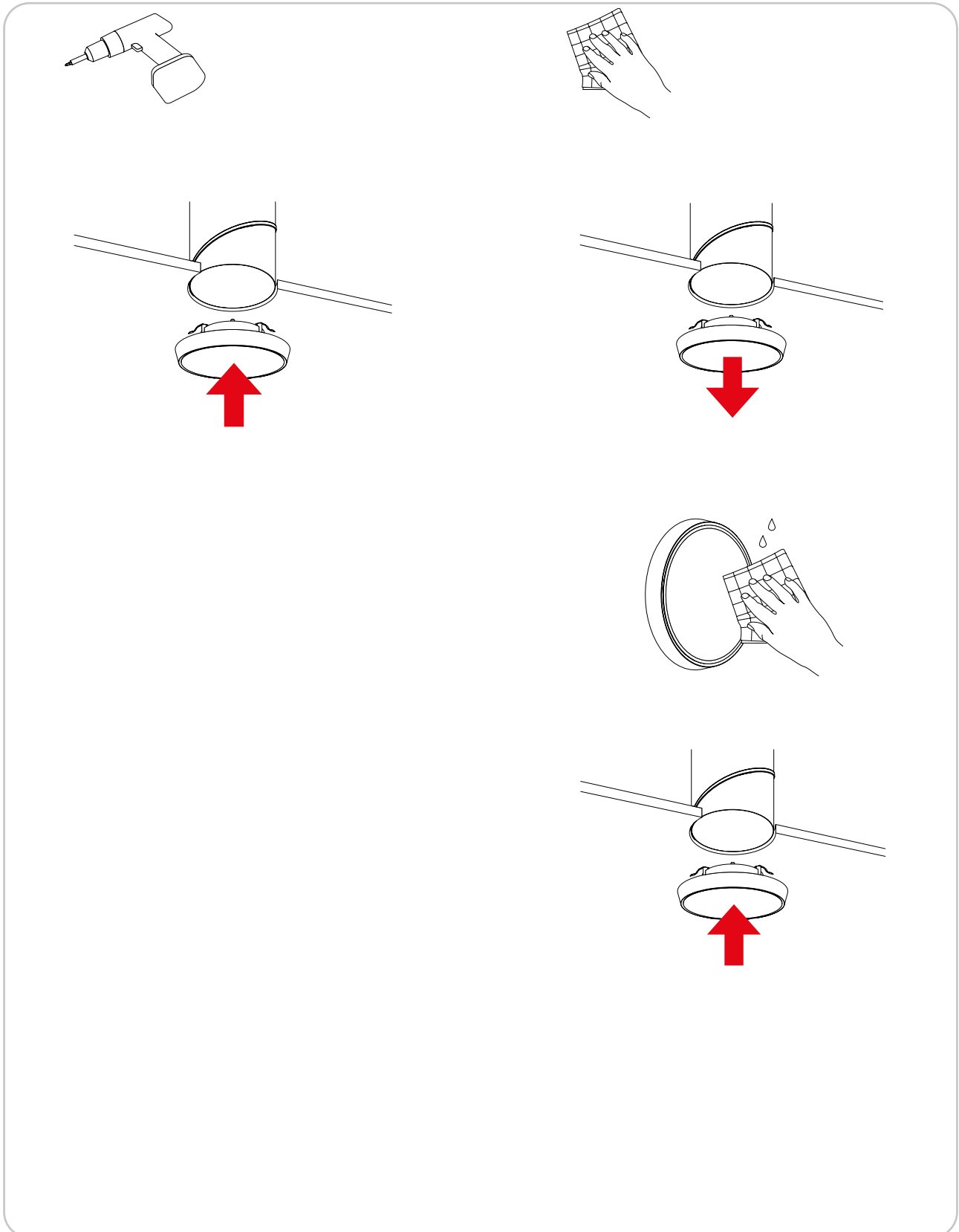

Ventil

KPT

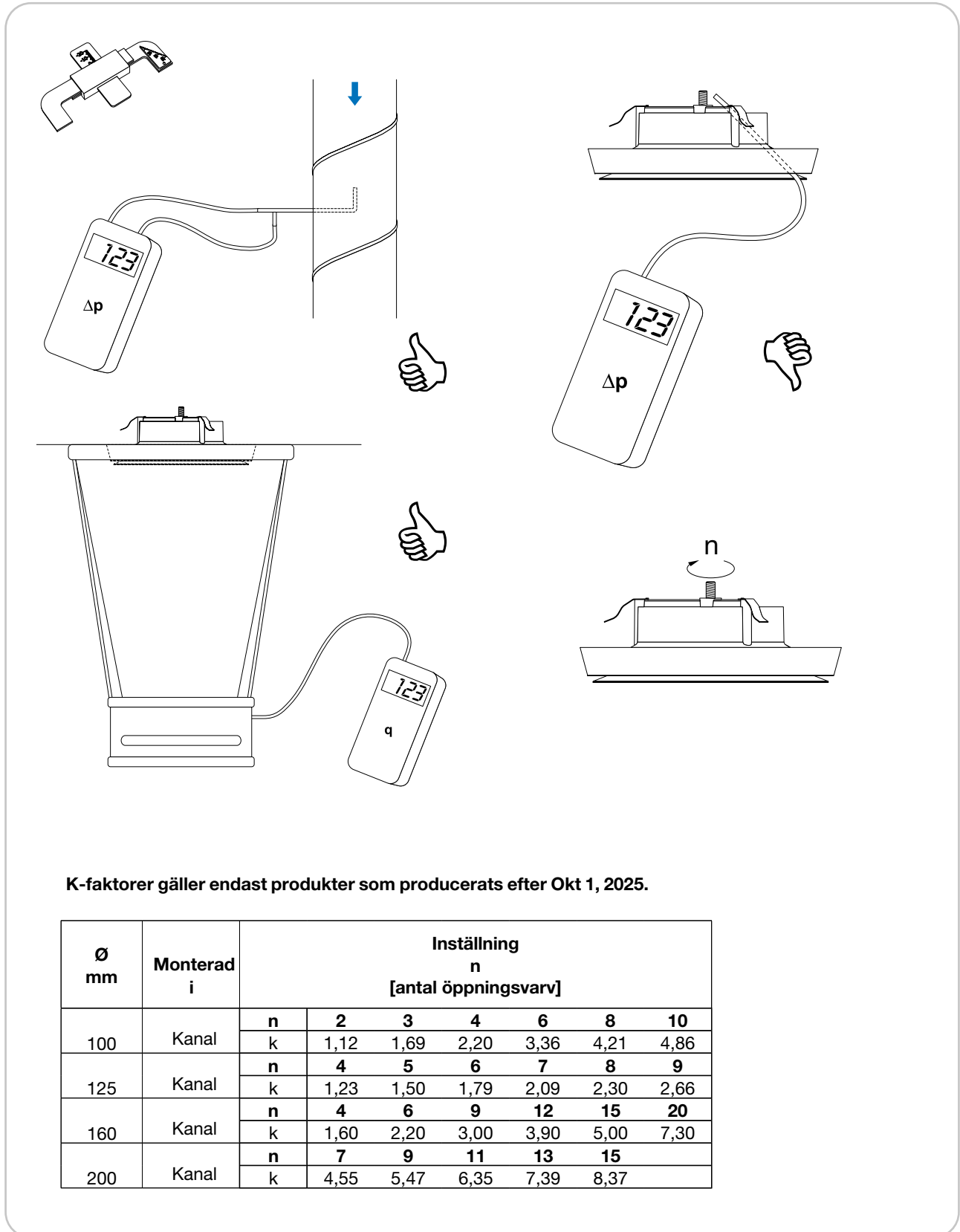

K-faktorer gäller endast produkter som producerats efter Okt 1, 2025.

Ø mm	Monterad i	Inställning n [antal öppningsvarv]						
		n	2	3	4	6	8	10
100	Kanal	k	1,12	1,69	2,20	3,36	4,21	4,86
		n	4	5	6	7	8	9
125	Kanal	k	1,23	1,50	1,79	2,09	2,30	2,66
		n	4	6	9	12	15	20
160	Kanal	k	1,60	2,20	3,00	3,90	5,00	7,30
		n	7	9	11	13	15	
200	Kanal	k	4,55	5,47	6,35	7,39	8,37	

Ventil

KPT

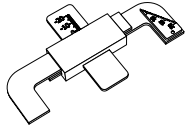

Ø mm	Monterad i	Inställning n [antal öppningsvarv]						
		n	1	2	3	4	6	8
80	Kanal	k	1,08	1,42	1,83	2,30	2,92	3,77
		n	2	3	4	6	8	10
100	Kanal	k	1,12	1,69	2,20	3,36	4,21	4,86
		n	4	5	6	7	8	9
125	Kanal	k	1,23	1,50	1,79	2,09	2,30	2,66
		n	6	8	10	12		
160	Kanal	k	2,34	3,06	3,73	4,35		
		n	7	9	11	13	15	
200	Kanal	k	4,55	5,47	6,35	7,39	8,37	
		n						

Tilluftsdon

KI

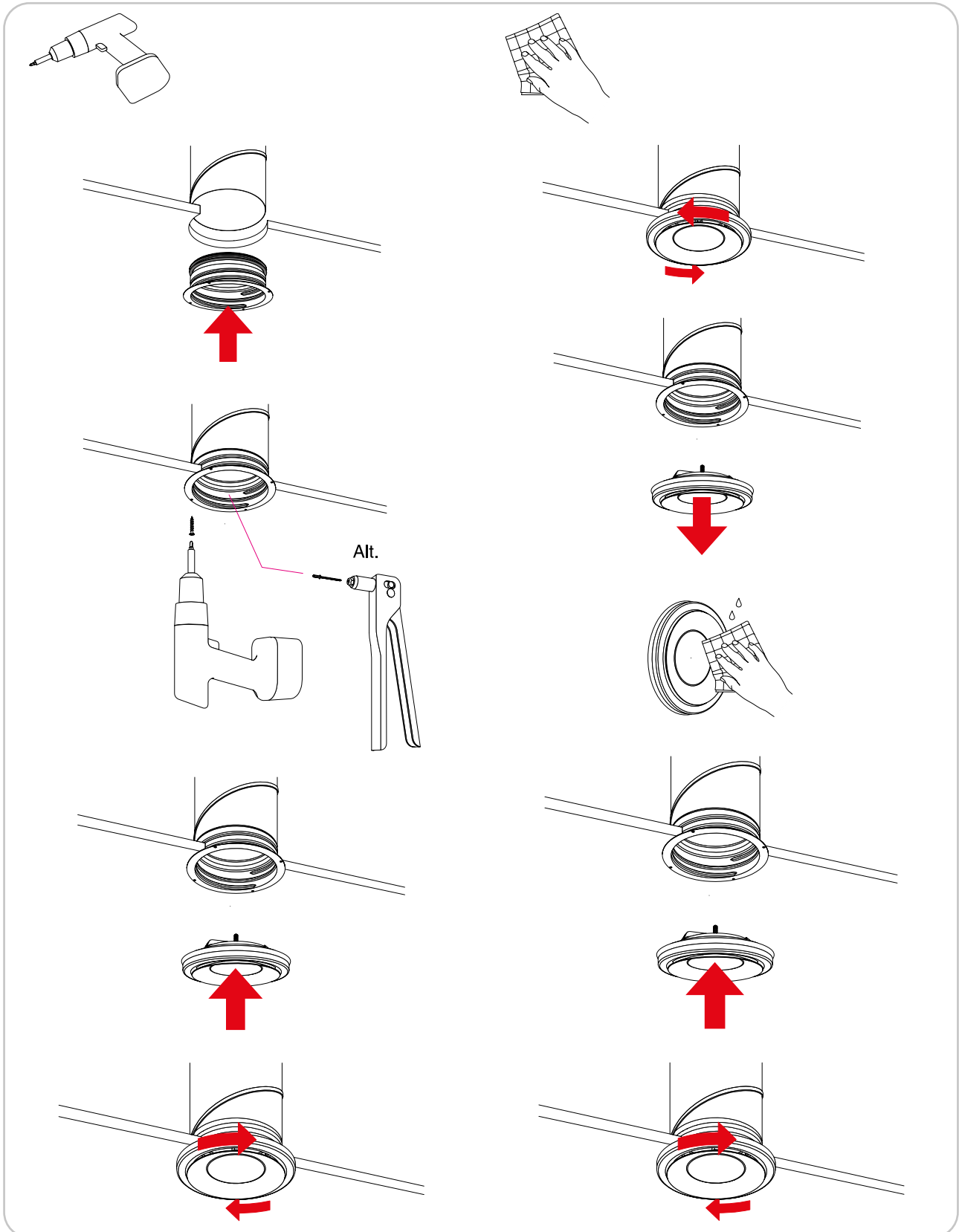

Tilluftsdon

KI

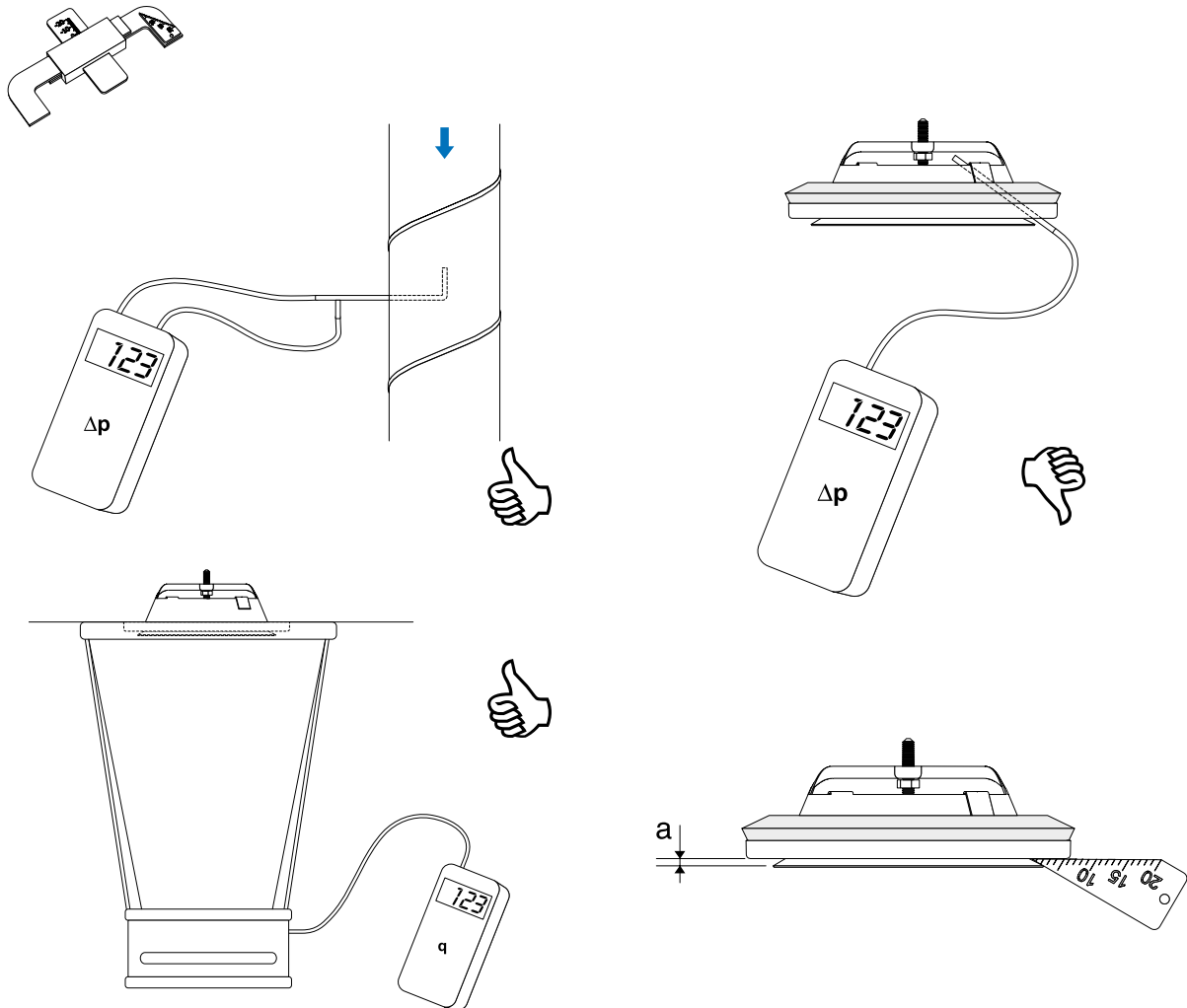

K-faktorer gäller endast produkter som producerats efter Okt 1, 2025.

Ø mm	Monterad i	Inställning a [mm]						
		a	2	4	6	9		
80	Kanal	k	0,76	1,51	2,52	4,22		
		a	2	4	6	9	12	
100	Kanal	k	0,80	1,65	2,50	4,10	5,30	
		a	2	5	7	9	12	15
125	Kanal	k	1,35	2,68	3,75	4,80	6,65	9,30
		a	6	9	12	15	20	
150	Kanal	k	3,97	5,73	7,83	10,4	12,5	
		a	4	6	9	12	15	20
160	Kanal	k	2,70	4,10	6,20	8,20	9,90	14,2
		a	5	7	9	12	15	20
200	Kanal	k	4,10	5,80	7,40	9,50	12,4	15,9

Tilluftsdon

KI

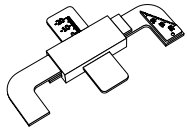

Ø mm	Monterad i	Inställning a [mm]						
		a	2	4	6	9	12	
80	Kanal	k	0,779	1,36	2,05	2,65	2,80	
		a	2	4	6	9	12	
100	Kanal	k	1,00	1,10	2,31	3,19	4,12	
		a	2	4	6	9	12	
125	Kanal	k	1,23	1,85	2,83	3,74	5,08	6,21
		a	3	5	7	9	12	15
150	Kanal	k	2,35	3,37	4,50	5,74	7,40	10,3
		a	4	6	9	12	15	20
160	Kanal	k	1,66	3,10	4,31	6,04	7,34	10,3
		a	4	6	9	12	15	20
200	Kanal	k	3,66	5,17	7,05	8,00	10,4	12,9
		a	5	6	9	12	15	20

Tilluftsdon

KIR

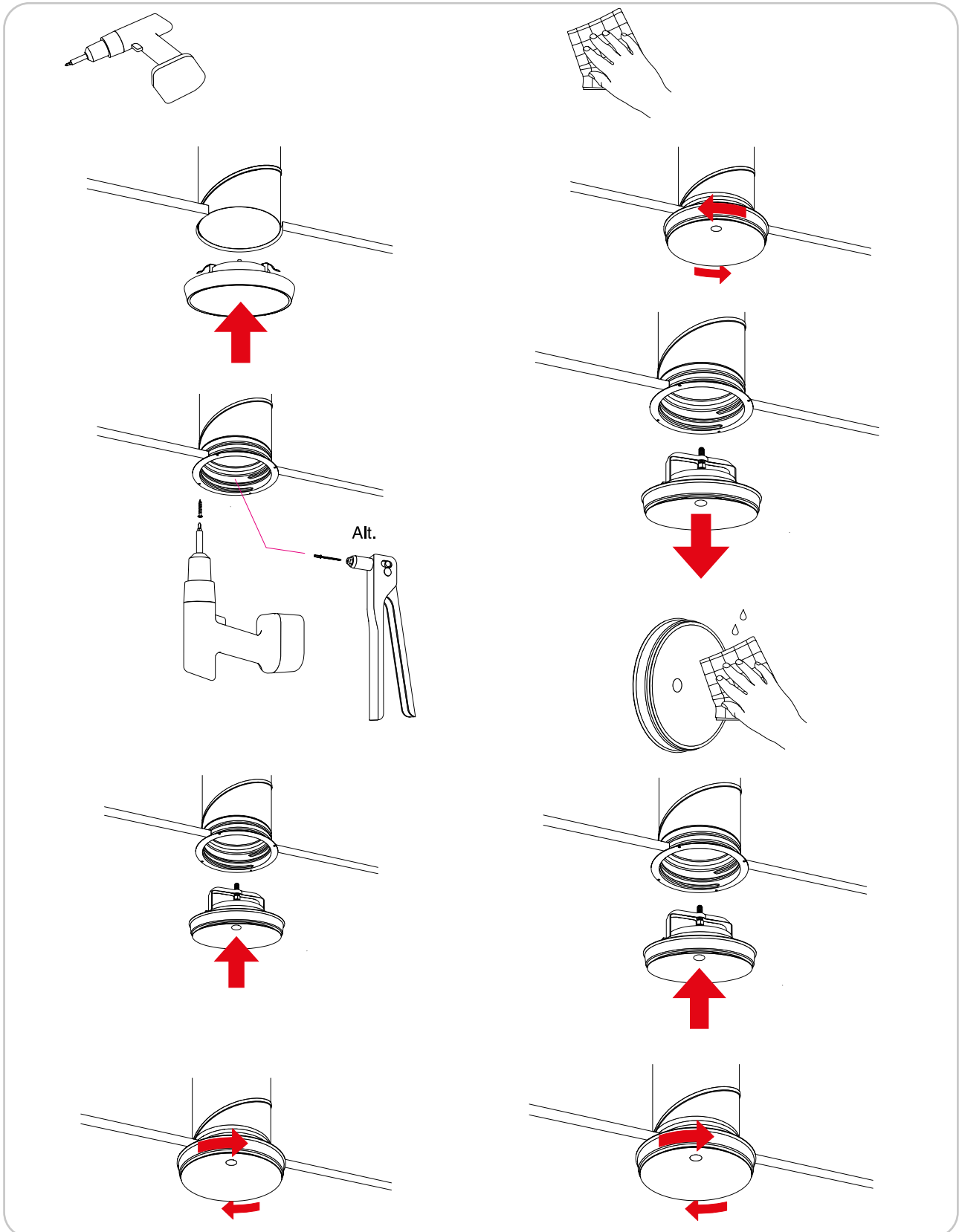

Tilluftsdon

KIR

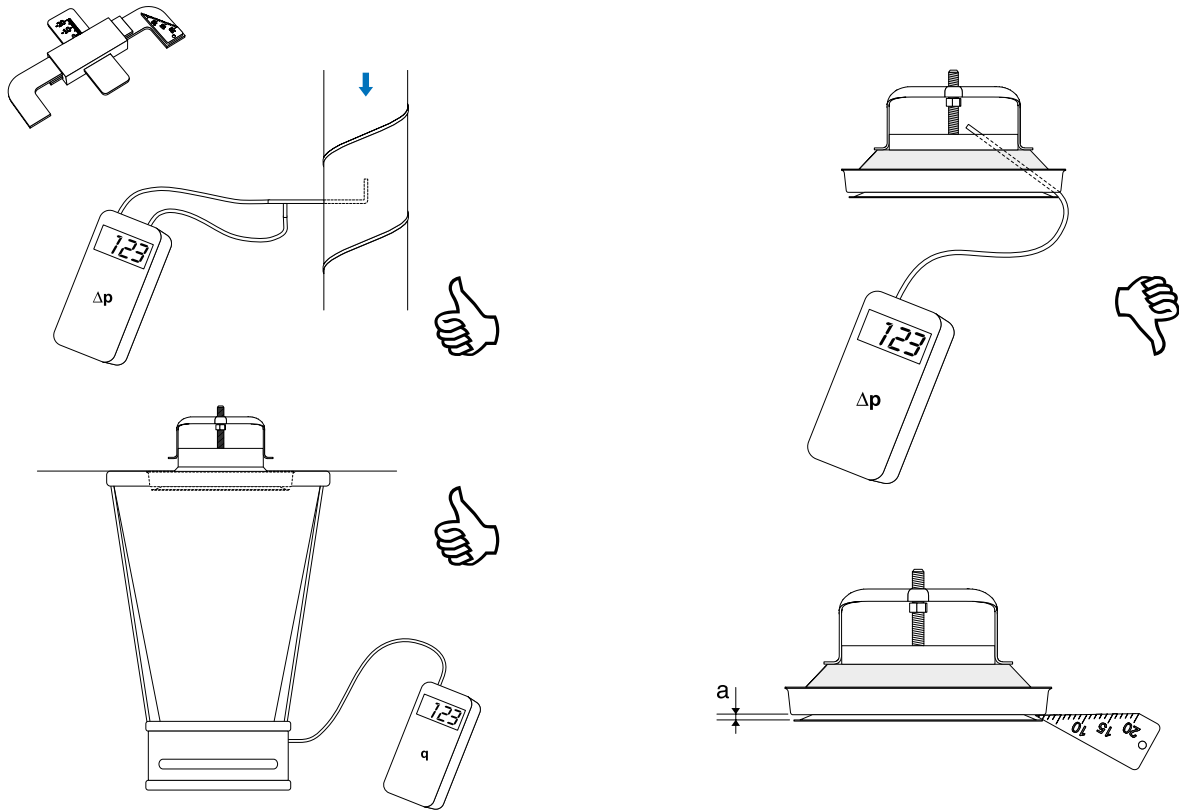

K-faktorer gäller endast produkter som producerats efter Okt 1, 2025.

Utan styrplåt

Ø mm	Monterad i	Inställning a [mm]						
		a	2	4	6	9	12	15
100	Kanal	k	0,85	1,72	2,35	3,40	4,50	4,70
		a	4	6	9	12	15	
125	Kanal	k	2,30	3,25	4,55	5,80	6,80	
		a	4	6	9	15	20	
160	Kanal	k	3,05	4,30	6,00	10,40	12,60	
		a	4	6	9	15	20	

Med styrplåt

Ø mm	Monterad i	Inställning a [mm]						
		a	2	4	6	9	12	15
100	Kanal	k	0,95	1,45	1,85	2,30	2,70	3,80
		a	4	6	9	12	15	
125	Kanal	k	2,05	2,68	3,20	3,70	4,80	
		a	4	6	9	15	20	
160	Kanal	k	2,70	3,90	4,75	6,40	7,70	
		a	4	6	9	15	20	

Tilluftsdon

KIR

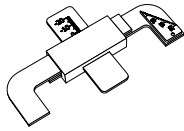

Utan styrplåt

Ø mm	Monterad i	Inställning a [mm]					
		a	2	4	6	9	12
100	Kanal	k	1,09	1,56	2,11	2,81	4,31
		a	4	6	9	12	15
125	Kanal	k	1,95	2,99	4,41	5,72	7,41
		a	4	6	10	15	20
160	Kanal	k	2,10	3,74	5,83	9,66	12,8
		a	4	6	10	15	20

Med styrplåt

Ø mm	Monterad i	Inställning a [mm]					
		a	2	4	6	9	12
100	Kanal	k	0,882	1,45	1,75	2,49	2,89
		a	4	6	9	12	15
125	Kanal	k	1,97	2,65	3,40	4,23	4,77
		a	4	6	10	15	20
160	Kanal	k	1,69	2,73	4,39	5,91	7,35
		a	4	6	10	15	20

Tallriksventil

TAV

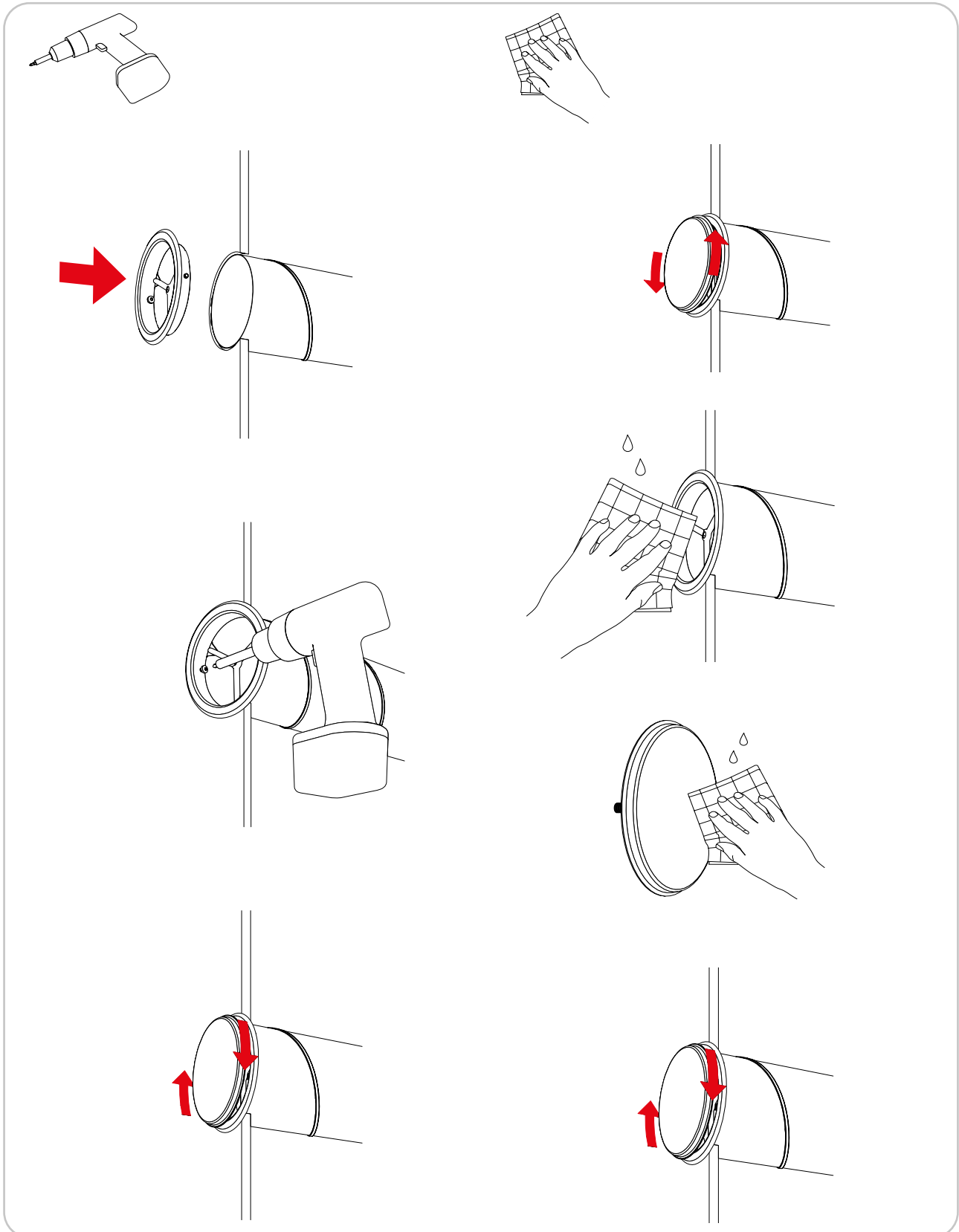

Kontrollventil

KVB

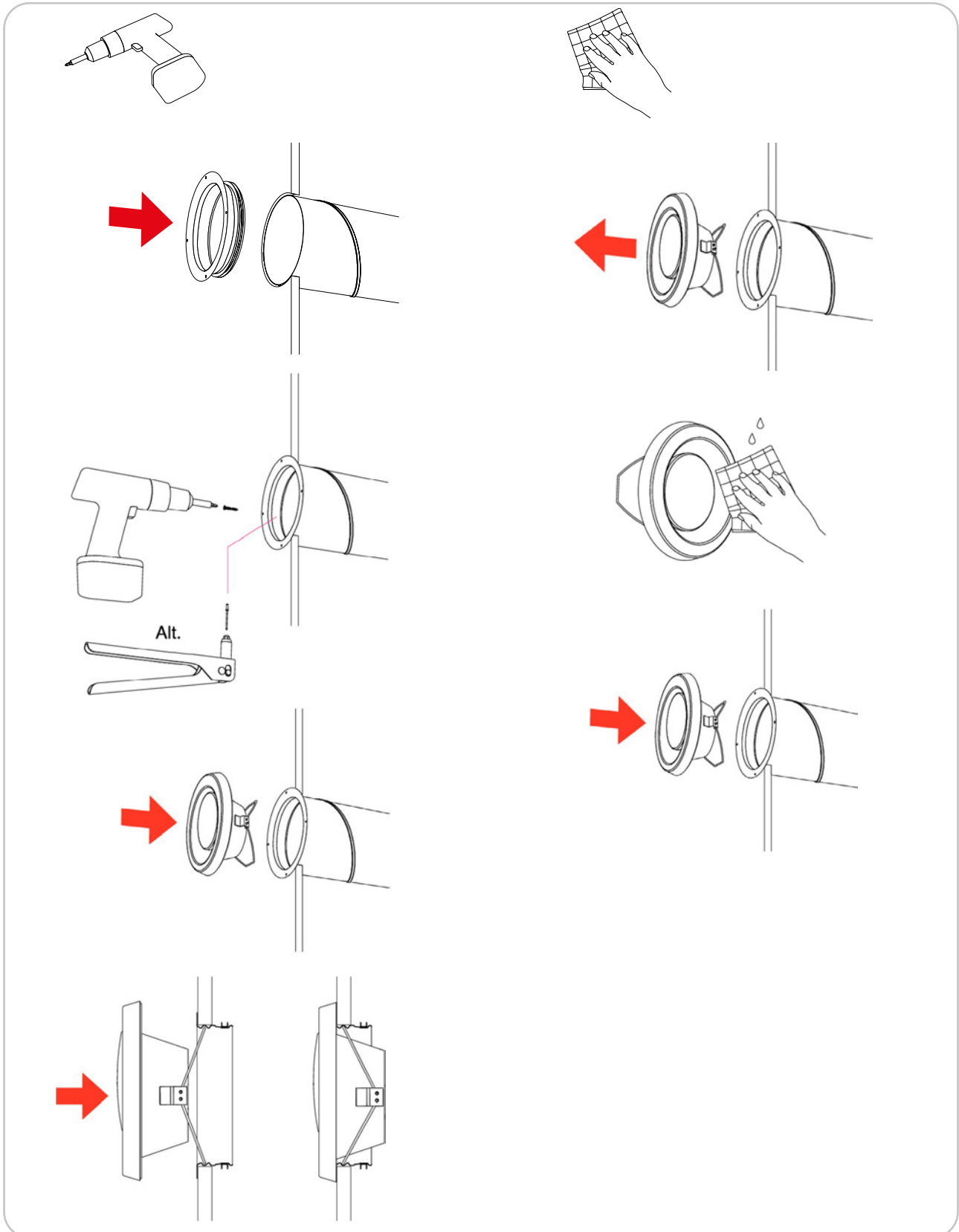

Kontrollventil

KVB

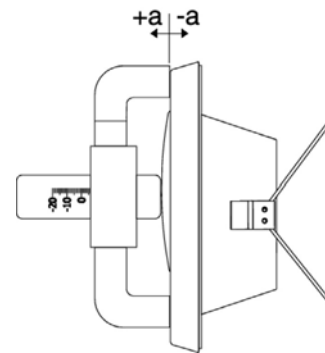
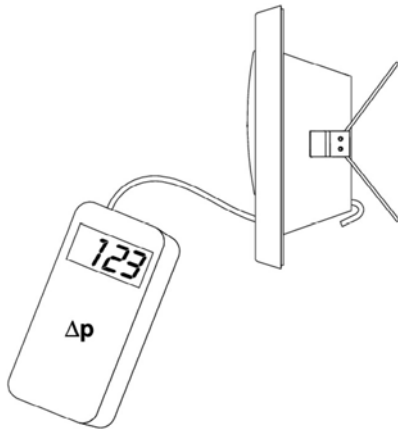
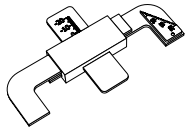

K-faktorer gäller endast produkter som producerats efter Okt 1, 2025.

Ø mm	Monterad i	Inställning a [mm]									
		a	-11	-9	-6	-3	0	3	6	10	
100	Kanal	k	0,40	0,55	0,80	1,10	1,40	1,70	2,00	2,30	
		a	-20	-16	-12	-8	-4	0	4	8	
125	Kanal	k	1,10	1,40	2,00	2,30	2,80	3,20	3,60	4,00	
		a	-23	-20	-15	-10	-5	0	5	10	15
160	Kanal	k	1,70	1,90	3,00	4,20	5,50	6,70	7,90	8,90	10,5

Kontrollventil

KVB

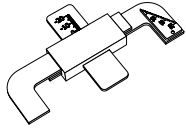

Ø mm	Monterad i	Inställning a [mm]						
		a	-11	-9	-6	0	6	9
100	Kanal	a	0,389	0,547	0,818	1,37	1,87	2,08
	Böj 90°	k	0,382	0,540	0,830	1,41	1,98	2,20
	T-rör		0,393	0,551	0,851	1,45	1,98	2,18
125	Kanal	a	1,32	1,88	2,47	3,01	3,46	
	Böj 90°	k	1,26	1,80	2,46	2,90	3,46	
	T-rör		1,40	1,81	2,63	3,11	3,72	
160	Kanal	a	2,05	2,50	3,31	4,23	5,11	5,73
	Böj 90°	k	1,76	2,33	3,15	3,93	4,72	5,29
	T-rör		-	2,80	3,29	4,04	4,88	5,41

Kontrollventil

KDPF

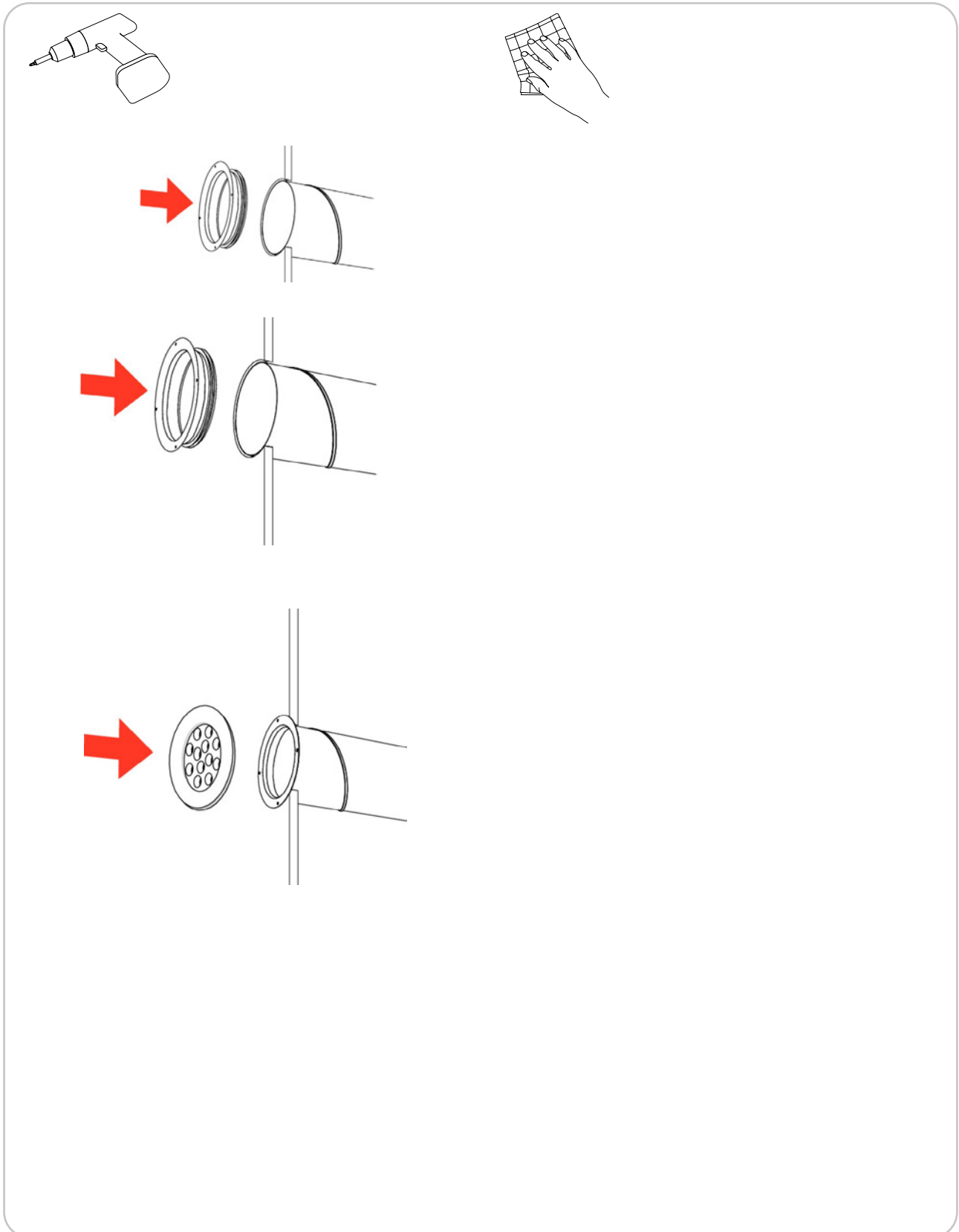

Kontrollventil

KDPF

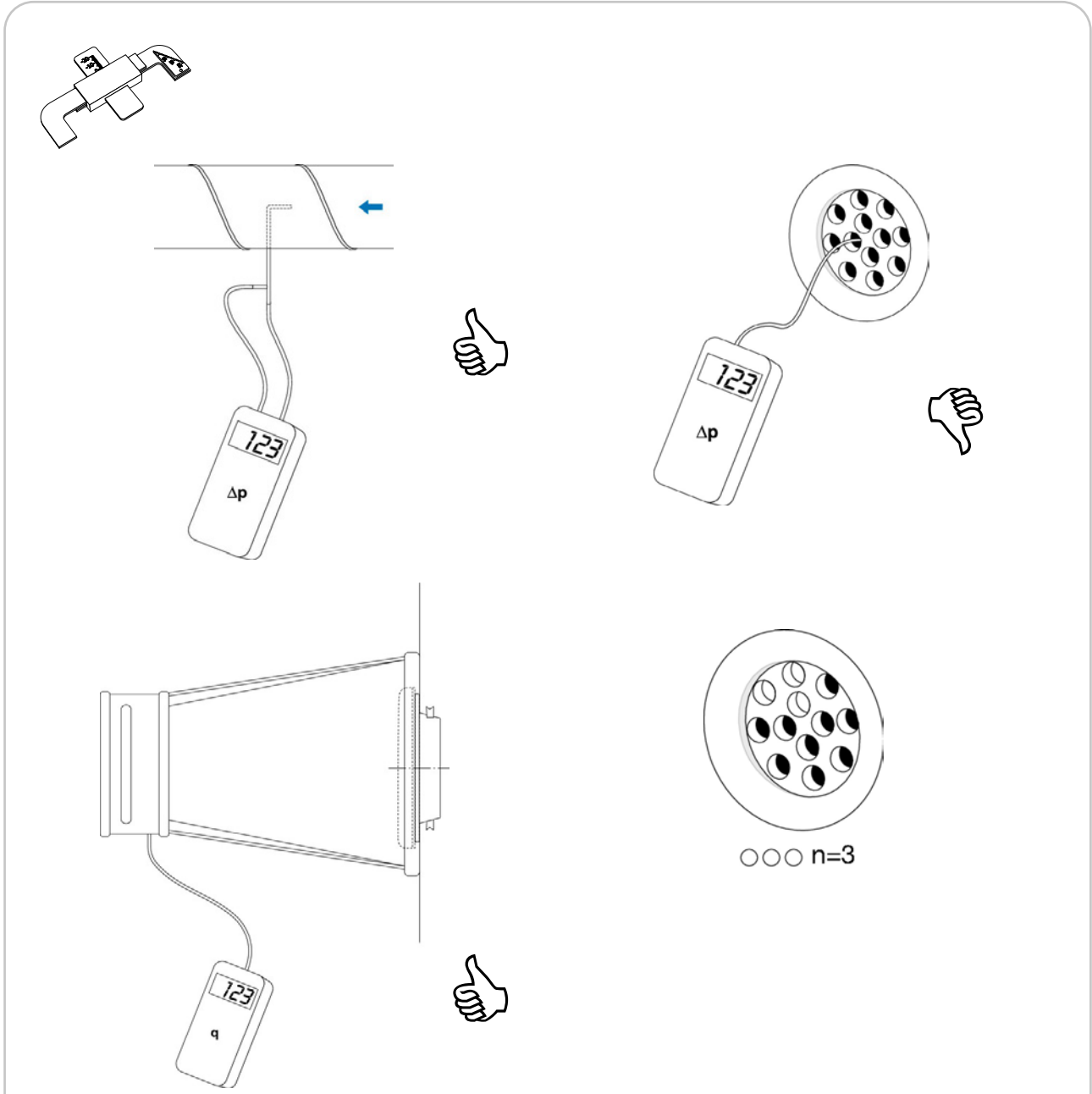

K-faktorer gäller endast produkter som producerats efter Okt 1, 2025.

Ø mm	Monterad i	Inställning n [antal öppna hål]							
		n k	2	3	4	6	8	10	12
100	Kanal		0,60	0,72	0,93	1,28	1,69	2,20	2,65

Kontrollventil

KDPF

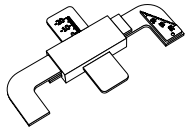

Ø mm	Monterad i	Inställning n [antal öppna hål]						
		n	1	2	3	4	5	6
100	Kanal	k	0,24	0,42	0,59	0,80	0,98	1,20
		n	7	8	9	10	11	12
	Kanal	k	1,50	1,60	1,80	2,10	2,30	2,50
		n						

Kontrollventil

KVG Ø100–160

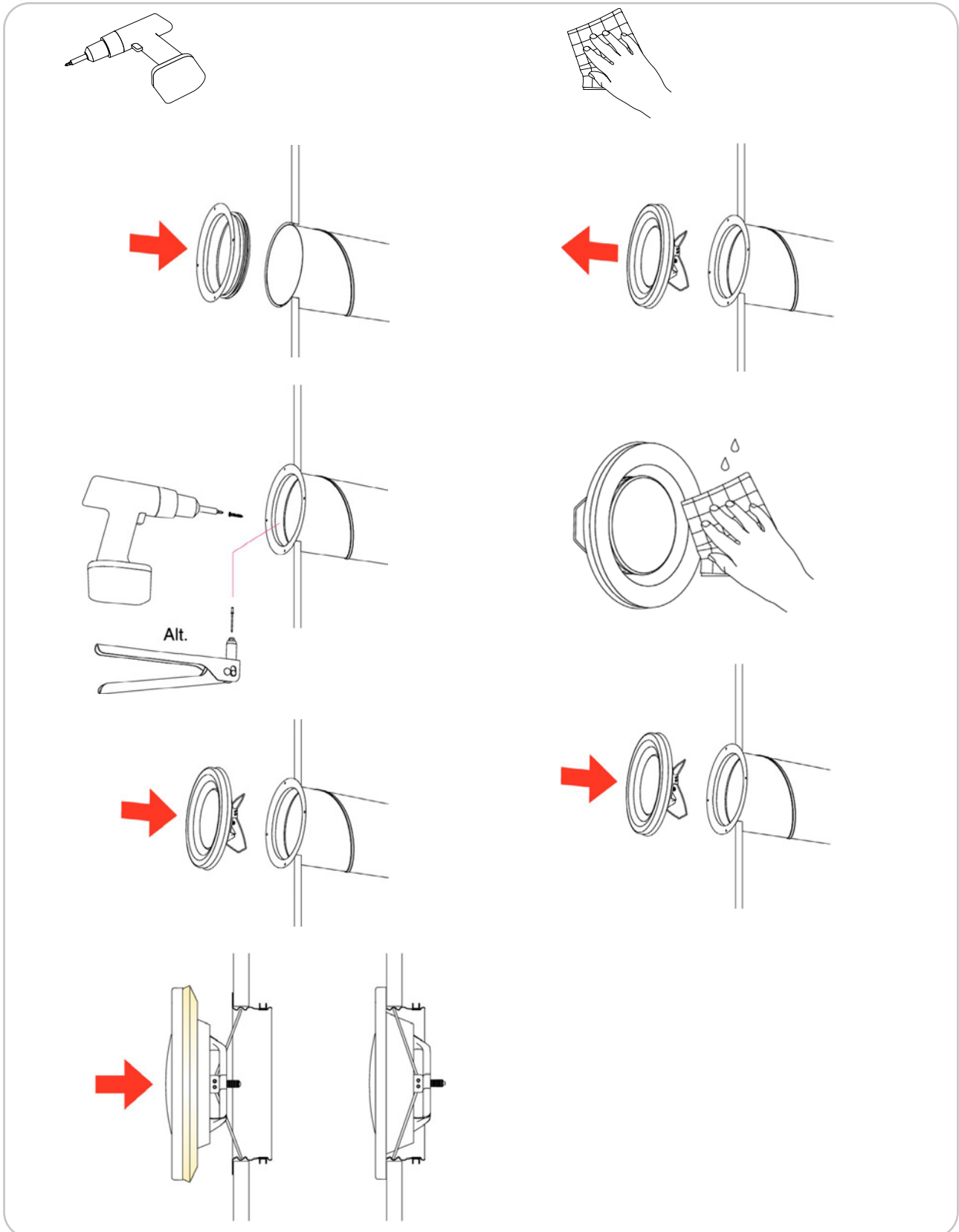

Kontrollventil

KVG Ø100–160

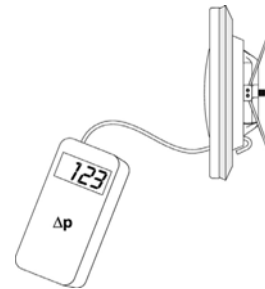
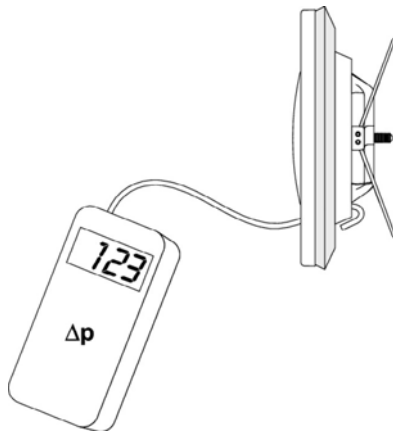
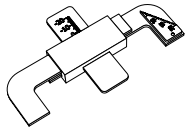

K-faktorer gäller endast produkter som producerats efter Okt 1, 2025.

Ø mm	Monterad i	Inställning a [mm]									
		a	-9	-6	-3	0	3	6	9	12	15
100	Kanal	k	0,70	1,10	1,40	1,80	2,10	2,50	2,90	3,30	3,30
		a	-17	-13	-9	-6	-3	0	5	10	15
125	Kanal	k	0,90	1,40	2,10	2,70	3,10	3,50	4,30	5,00	5,80
		a	-20	-15	-10	-5	0	5	10	15	20
160	Kanal	k	0,70	1,60	2,60	3,60	4,50	4,50	5,50	6,50	7,50
		a	-20	-15	-10	-5	0	5	10	15	20

Kontrollventil

KVG Ø100–160

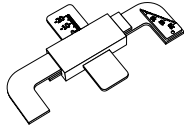

Ø mm	Monterad i	Inställning a [mm]									
		a	-9	-5	0	5	8	12			
100	Kanal Böj 90° T-rör	a	0,577	1,25	1,85	2,39	2,75	3,07			
		k	0,549	1,15	1,87	2,53	2,86	3,27			
			0,788	1,34	1,78	2,37	2,89	2,99			
125	Kanal Böj 90° T-rör	a	-17	-13	-9	-6	-3	0	5	10	15
		k	0,736	1,27	1,96	2,41	2,93	3,36	3,96	4,79	5,85
			0,651	1,31	2,06	2,49	3,35	3,62	5,03	5,43	7,05
160	Kanal Böj 90° T-rör	a	-18	-14	-10	-5	0	6	12	18	
		k	1,05	1,68	2,33	3,50	4,60	5,62	6,58	7,70	
			1,05	1,71	2,48	3,43	4,35	5,25	6,33	7,49	
		-	1,91	2,68	3,54	4,40	5,60	6,80	7,49		

Kontrollventil

KVG Ø200

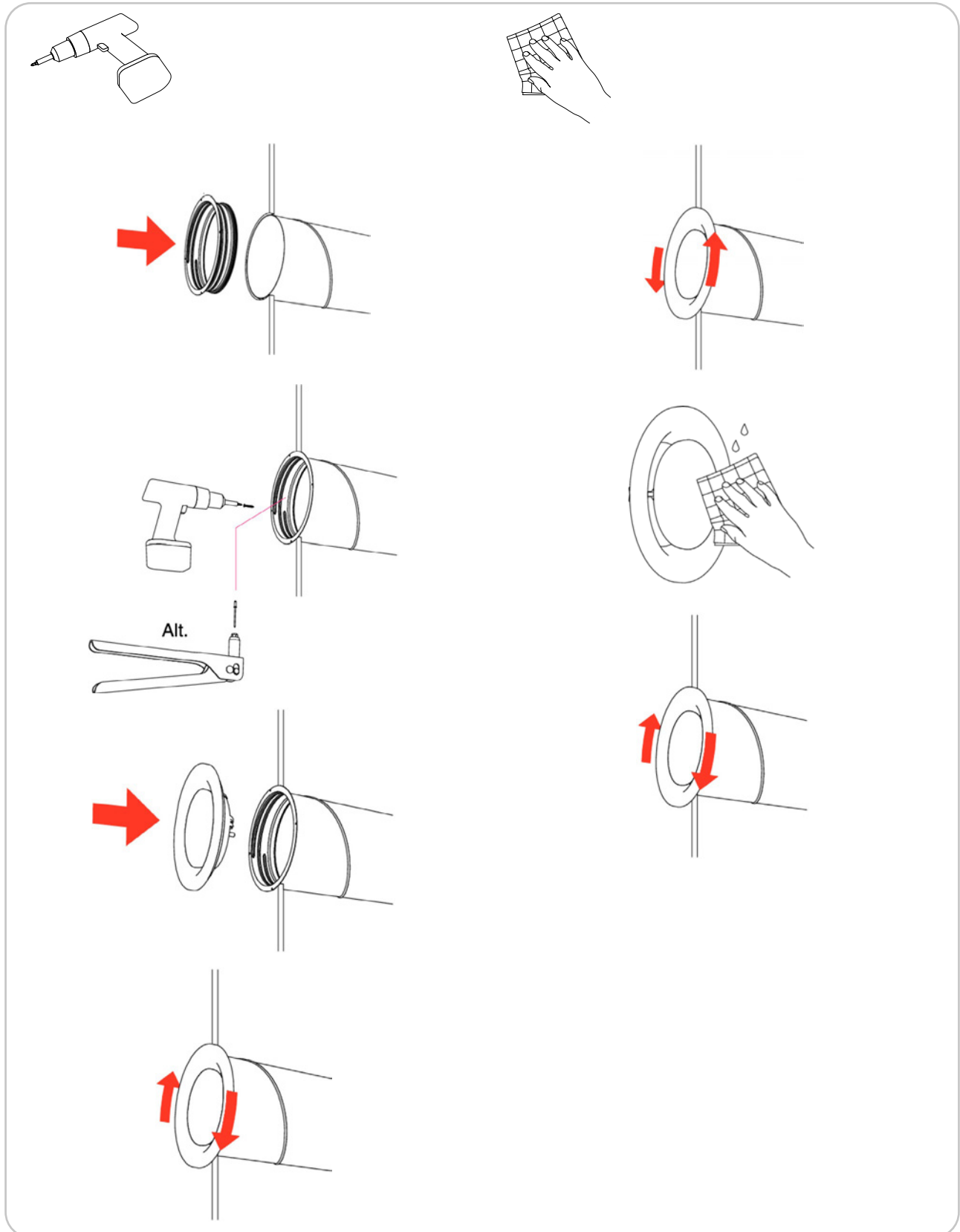

Kontrollventil

KVG Ø200

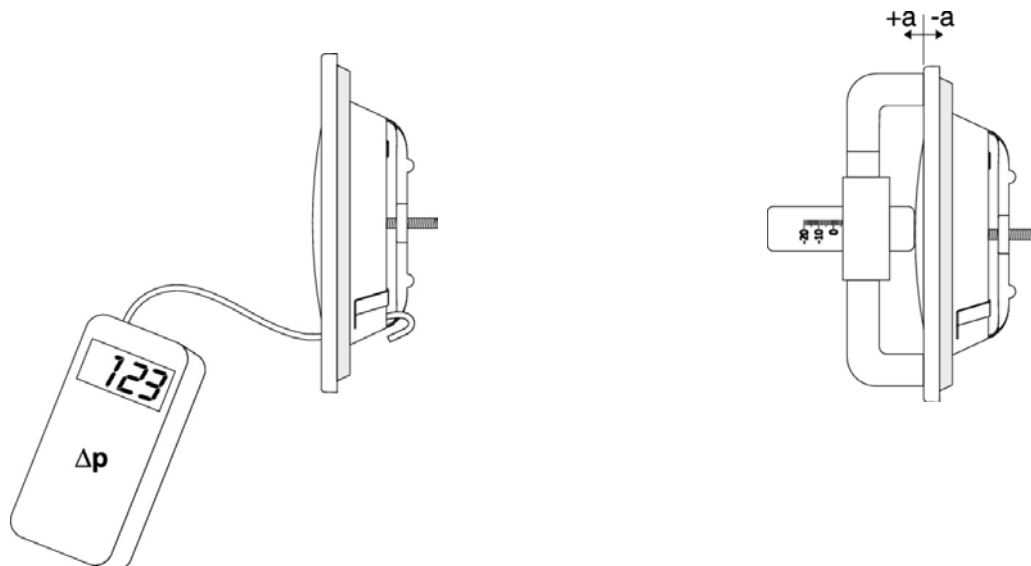
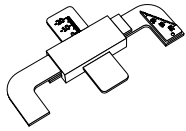

K-faktorer gäller endast produkter som producerats efter Okt 1, 2025.

Ø mm	Monterad i	Inställning a [mm]								
		a k	-20	-15	-10	-5	0	5	10	15
200	Duct	k	1,90	3,00	4,20	5,50	6,70	7,90	8,90	10,50

Kontrollventil

KVG Ø200

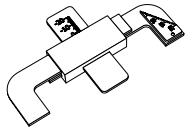

Ø mm	Monterad i	Inställning a [mm]								
		a	-23	-18	-15	-10	-5	0	10	20
200	Duct									
	Bend 90°	k	1,94	3,23	3,94	4,94	6,32	7,80	10,0	12,6
	T-piece		1,86	2,99	3,95	5,08	6,14	7,62	10,1	11,2
			-	3,28	4,02	5,36	6,75	7,57	10,5	12,5

Kontrollventil

KU

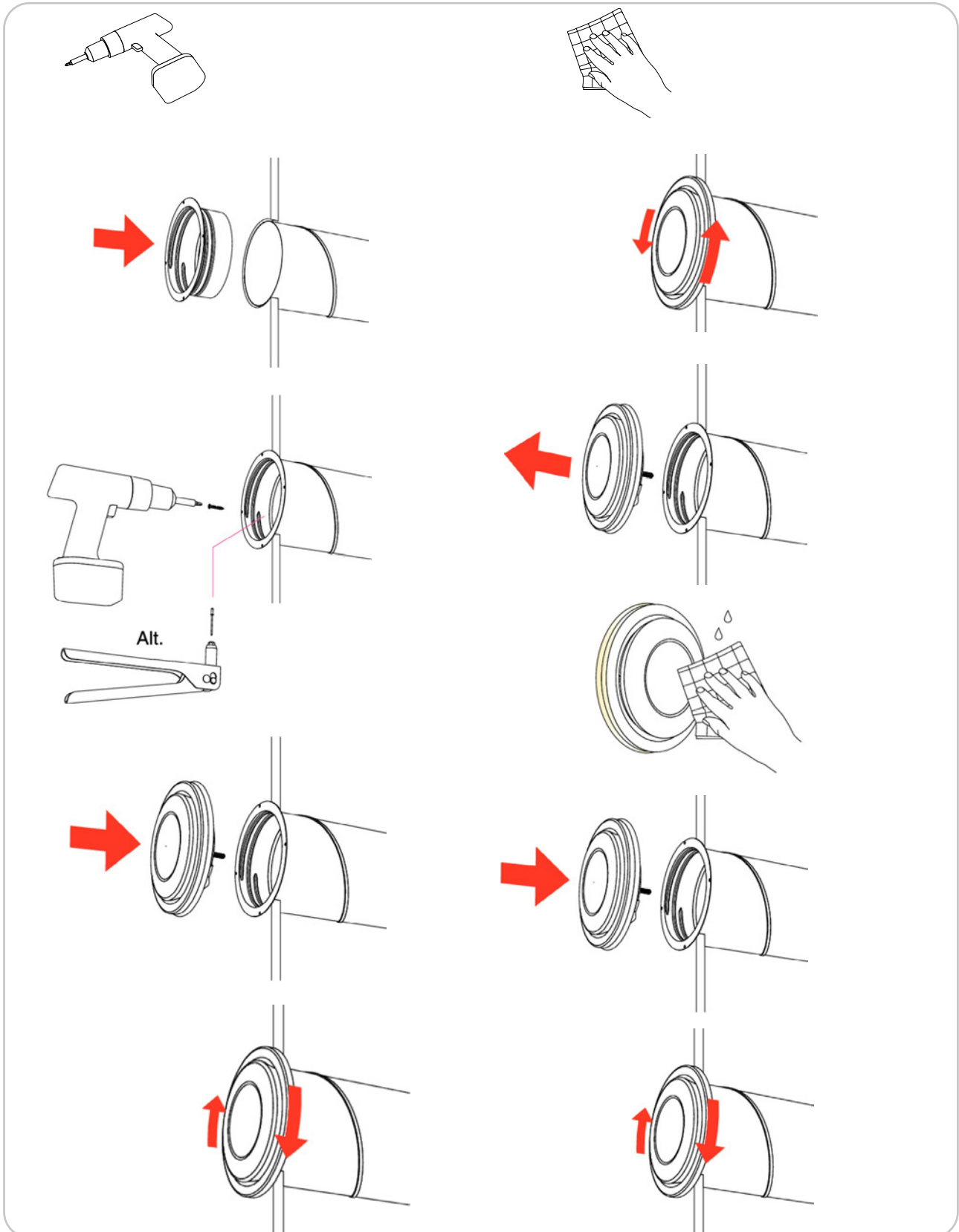

Kontrollventil

KU

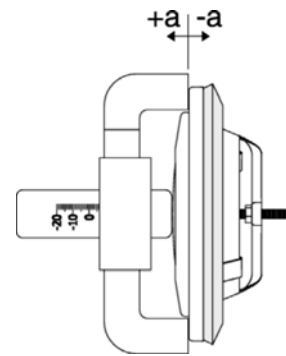
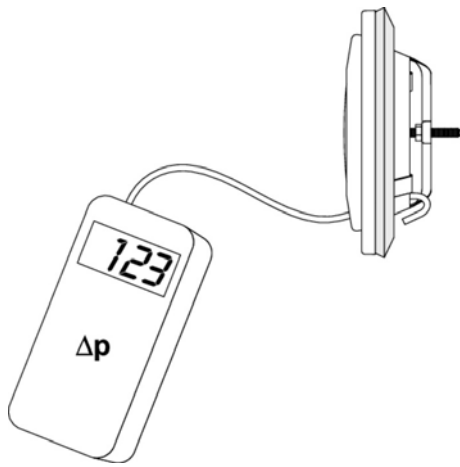
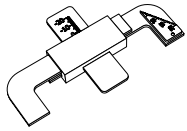

K-faktorer gäller endast produkter som producerats efter Okt 1, 2025.

Ø mm	Monterad i	Inställning a [mm]									
		a	-9	-6	-3	0	3	6			
80	Kanal	k	0,62	0,85	1,25	1,42	1,70	2,00			
		a	-12	-9	-5	0	5	10			
100	Kanal	k	0,45	0,75	1,05	1,75	2,40	3,05			
		a	-16	-13	-9	-6	-3	0	5	10	
125	Kanal	k	0,35	0,85	1,41	1,85	2,22	2,69	3,42	4,37	
		a	-15	-12	-9	-6	-3	0	3	6	9
150	Kanal	k	1,45	2,00	2,50	3,10	3,60	4,10	4,68	5,30	5,80
		a	-15	-10	-5	0	5	10	15	20	
160	Kanal	k	1,15	2,11	3,10	3,95	5,10	6,35	7,60	8,90	
		a	-20	-15	-10	-5	0	5	10	15	20
200	Kanal	k	2,75	4,00	5,20	6,30	7,50	8,80	10,0	11,6	12,8
		a	-20	-15	-10	-5	0	5	10	15	20

Kontrollventil

KU

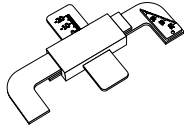

Ø mm	Monterad i	Inställning a [mm]									
		a	-9	-6	-3	0	3	6			
80	Kanal	a	0,679	0,941	1,32	1,59	1,90	2,13			
	Böj 90°	k	0,715	1,02	1,23	1,54	1,75	2,06			
	T-rör		0,732	1,00	1,35	1,54	1,79	1,95			
100	Kanal	a	0,560	0,938	1,46	2,00	2,72				
	Böj 90°	k	0,632	1,02	1,44	2,20	2,78				
	T-rör		-	1,08	1,54	2,17	2,91				
125	Kanal	a	0,681	0,868	1,45	1,72	2,33	2,73	3,31	3,95	
	Böj 90°	k	0,616	0,854	1,40	1,86	2,35	2,75	3,11	4,01	
	T-rör		-	1,13	1,56	1,97	2,39	3,00	3,40	4,19	
150	Kanal	a	1,47	2,12	2,62	3,83	4,82	5,96			
	Böj 90°	k	1,60	2,01	2,61	4,00	4,96	6,61			
	T-rör		1,79	2,44	3,07	4,09	5,21	6,46			
160	Kanal	a	0,833	1,00	1,79	2,66	3,68	4,66	5,92	6,57	7,04
	Böj 90°	k	0,879	1,09	1,71	2,62	3,63	4,59	5,68	6,61	6,90
	T-rör		-	1,58	2,11	3,09	3,90	4,90	6,10	6,86	7,11
200	Kanal	a	2,39	3,65	5,02	5,77	7,18	8,39	11,4	13,7	
	Böj 90°	k	2,39	3,54	4,87	5,70	7,01	8,51	11,1	13,6	
	T-rör		2,39	4,04	5,15	6,33	7,58	8,45	10,9	14,3	

Kontrollventil

KSU

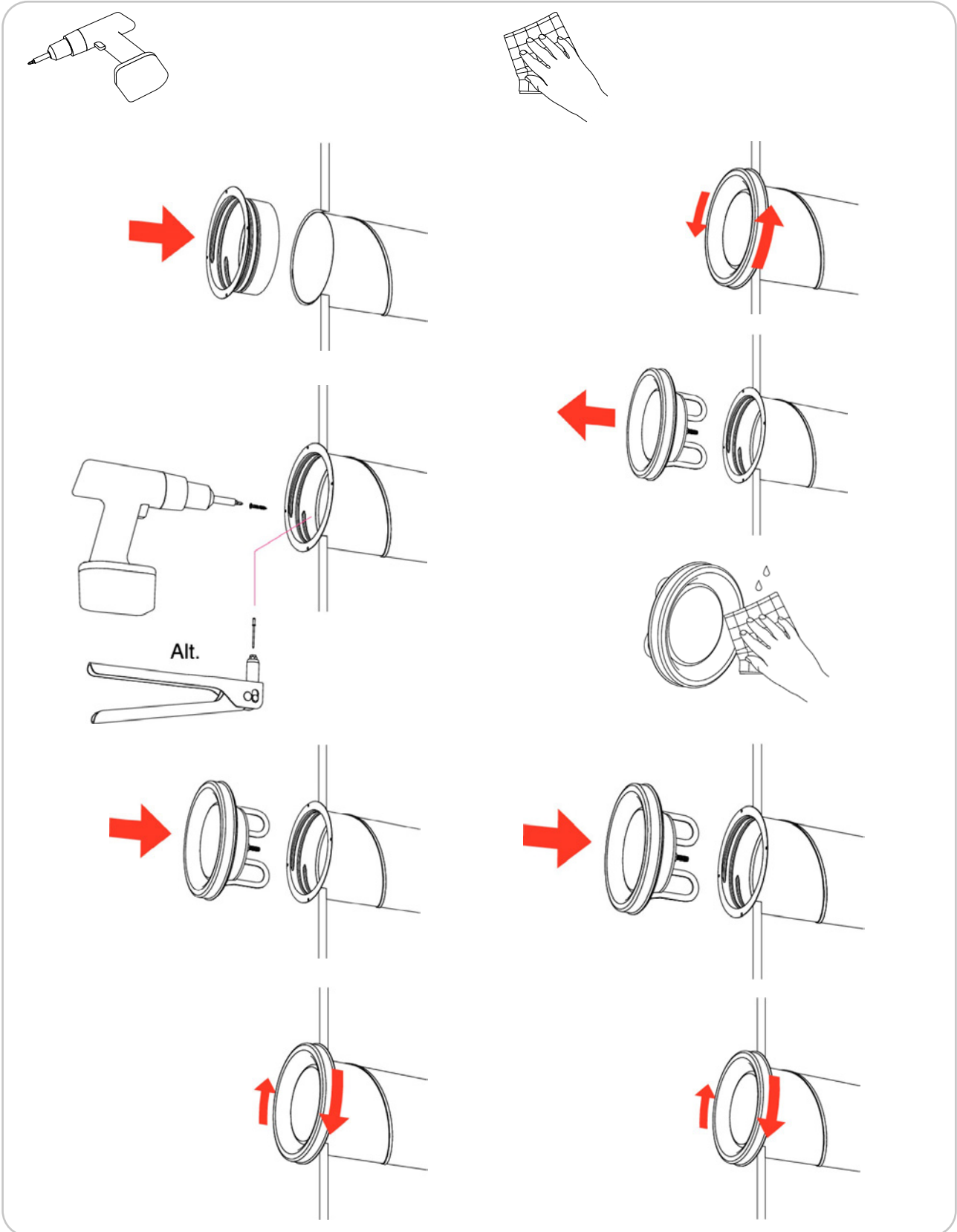

Kontrollventil

KSU

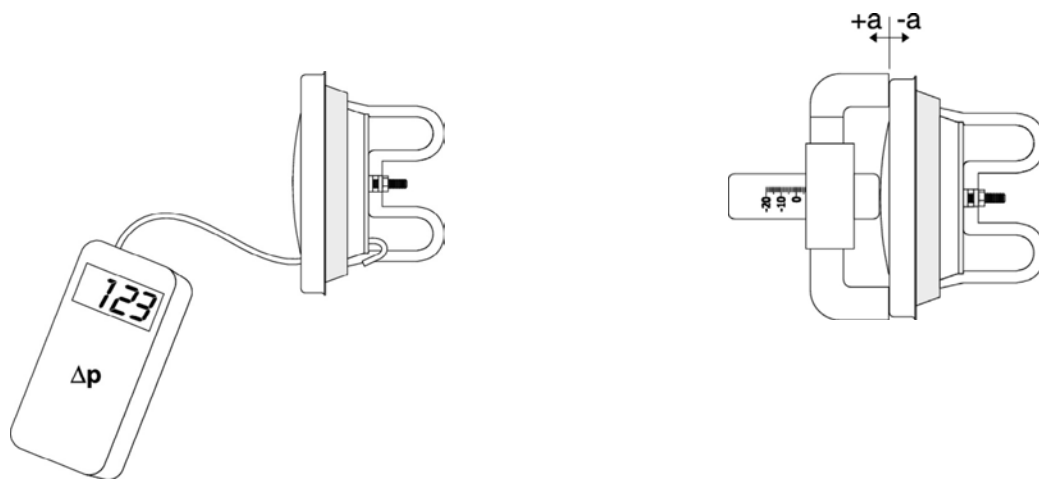
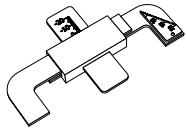

K-faktorer gäller endast produkter som producerats efter Okt 1, 2025.

Ø mm	Monterad i	Inställning a [mm]							
		a	-10	-7	-5	0	5	10	15
100	Kanal	a	-10	-7	-5	0	5	10	15
		k	0,37	0,67	0,87	1,29	1,78	2,35	2,80
125	Kanal	a	-10	-5	0	5	10		
		k	0,76	1,34	1,94	2,57	3,15		
150	Kanal	a	-10	-5	0	5	10	15	20
		k	1,68	2,47	3,31	4,07	4,87	5,79	6,67
160	Kanal	a	-10	-5	0	5	10	15	20
		k	1,68	2,47	3,31	4,07	4,87	6,46	6,67
200	Kanal	a	-5	0	5	10	15	20	
		k	1,40	2,55	3,75	5,00	6,30	7,60	

Kontrollventil

KSU

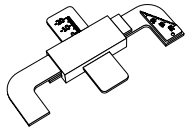

Ø mm	Monterad i	Inställning a [mm]							
		a	-15	-12	-10	-5	0	5	10
100	Kanal Böj 90° T-rör	a	0,459	0,676	0,861	1,36	1,82	2,32	2,75
		k	0,505	0,841	1,00	1,40	1,86	2,35	2,77
			0,576	0,850	1,01	1,42	1,89	2,35	2,66
125	Kanal Böj 90° T-rör	a	-10	-5	0	5	10		
		k	1,29	1,93	2,59	3,29	3,91		
			1,24	1,90	2,61	3,33	3,90		
150	Kanal Böj 90° T-rör	a	-10	-5	0	5	10	15	
		k	1,81	2,69	3,42	4,48	5,17	6,09	
			2,01	2,75	3,47	4,37	5,29	6,21	
160	Kanal Böj 90° T-rör	a	-10	-5	0	5	10	15	
		k	1,80	2,62	3,62	4,57	5,58	6,46	
			1,50	2,50	3,48	4,50	5,39	6,52	
200	Kanal Böj 90° T-rör	a	-3	0	5	10	15	20	25
		k	2,02	2,72	3,85	5,19	6,32	7,63	8,72
			1,65	2,62	3,71	5,21	6,07	7,40	8,60
		2,11	3,00	3,90	5,46	6,54	7,80	8,90	

Frånluftsdon

KPF

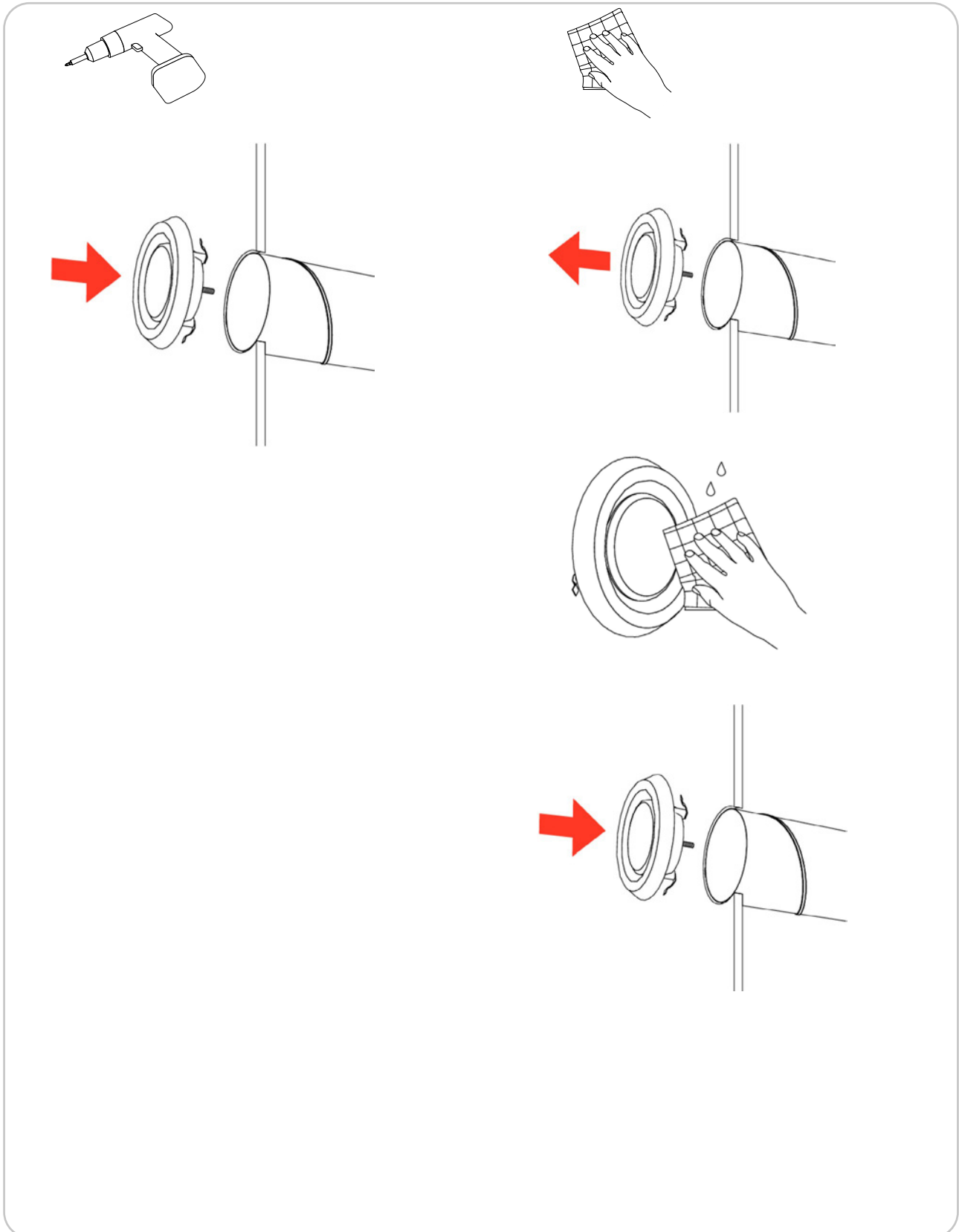

Frånluftsdon

KPF

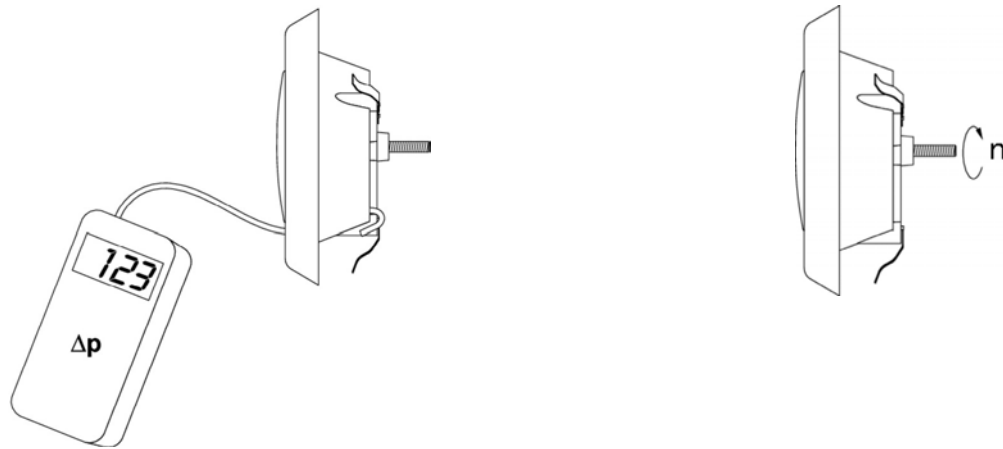
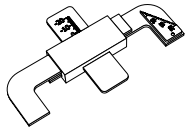

K-faktorer gäller endast produkter som producerats efter Okt 1, 2025.

Ø mm	Monterad i	Inställning n [antal varv]						
		n	0	3	6	9	12	15
80	Kanal	k	0,68	0,81	0,95	1,11	1,25	1,35
		n	0	3	6	12	15	18
100	Kanal	k	1,54	1,71	1,96	2,48	2,91	3,17
		n	0	3	6	9	12	15
125	Kanal	k	1,72	1,99	2,35	2,69	2,98	3,31
		n	0	3	6	9	12	15
160	Kanal	k	0,90	1,30	1,80	2,70	3,20	3,70
		n	-3	0	3	6	9	15
200	Kanal	k	1,77	2,57	3,26	4,23	4,93	5,84
		n	3	6	9	12	15	18

Frånluftsdon

KPF

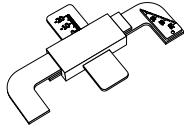

Ø mm	Monterad i	Inställning n [antal varv]						
		n	0	3	6	9	12	15
80	Kanal	n	0,489	0,675	1,08	1,07	1,55	1,42
	Böj 90°	k	0,517	0,621	0,867	1,10	1,31	1,42
	T-rör		–	0,715	0,915	1,14	1,18	1,41
100	Kanal	n	0	3	6	9	15	18
	Böj 90°	k	1,54	1,71	1,96	2,48	2,91	3,17
	T-rör		1,58	1,89	2,20	2,62	2,94	3,39
125	Kanal	n	0	3	6	9	12	15
	Böj 90°	k	1,76	1,99	2,44	2,89	3,31	3,67
	T-rör		1,82	1,95	2,42	2,74	3,21	3,56
160	Kanal	n	3	6	9	12	15	18
	Böj 90°	k	1,54	2,19	2,78	3,20	3,94	4,46
	T-rör		1,41	1,97	2,52	3,04	3,63	4,23
200	Kanal	n	3	6	9	12	15	18
	Böj 90°	k	1,77	2,57	3,26	4,23	4,93	5,84
	T-rör		1,78	2,45	3,26	3,48	4,89	5,14
			–	2,53	3,03	3,79	4,55	5,04

Täcklock

TLO

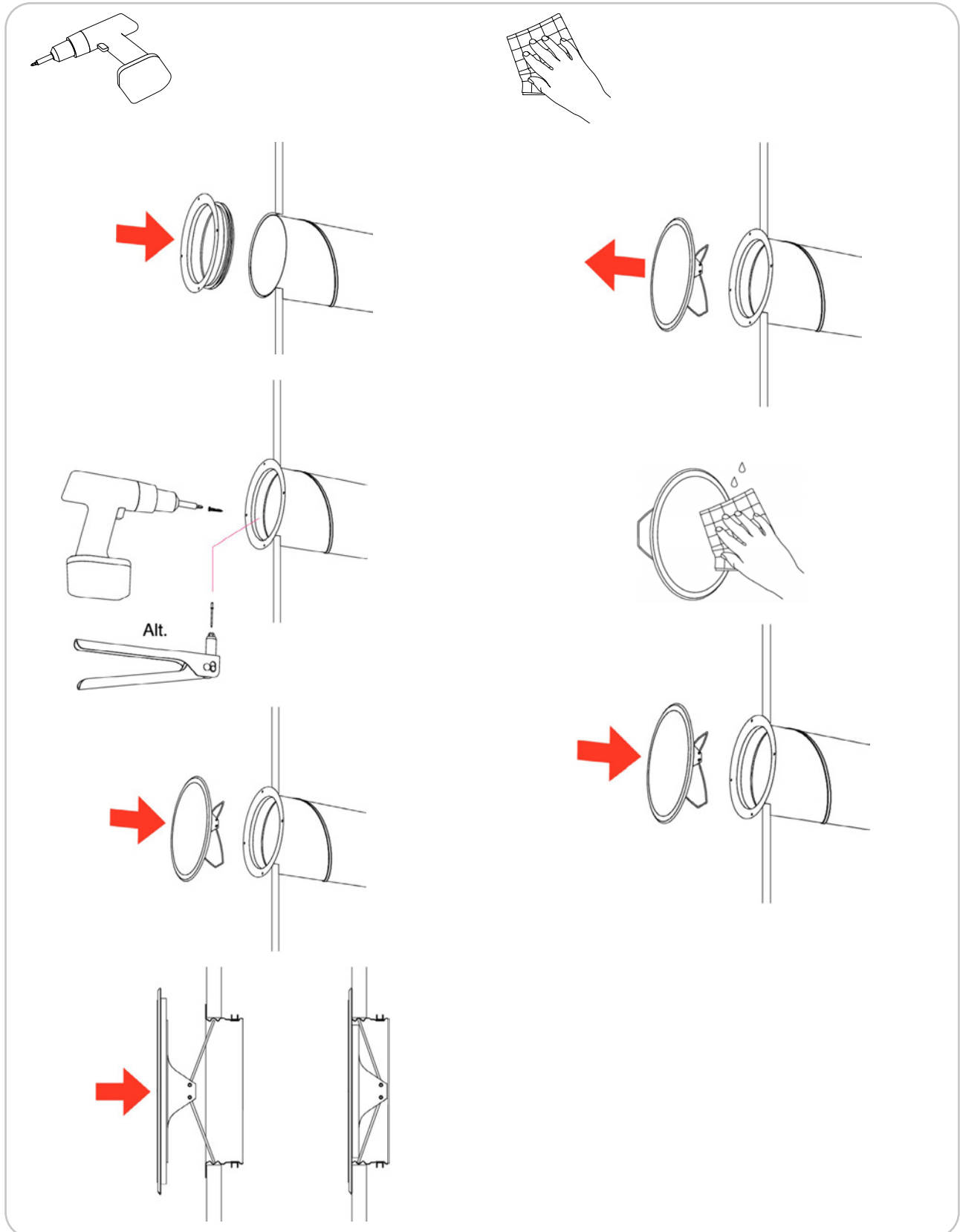



De flesta av oss tillbringar större delen av tiden inom-hus. Inomhusklimatet är avgörande för hur vi mår, hur mycket vi orkar och om vi håller oss friska.

Vi på Lindab har därför gjort till vår viktigaste uppgift att bidra till ett inomhusklimat som förbättrar människors liv. Det gör vi genom att utveckla energieffektiva ventilationslösningar och hållbara byggprodukter. Vi vill också bidra till ett bättre klimat för vår planet genom att arbeta på ett sätt som är hållbart för både människor och miljön.

Lindab | För ett bättre klimat